

### General Description

The QM04N65F1 is the highest performance N-ch MOSFETs with extreme high cell density, which provide excellent RDSON and gate charge for most of the synchronous buck converter applications.

The QM04N65F1 meet the RoHS and Green Product requirement, 100% EAS guaranteed with full function reliability approved.

### Features

- Super Low Gate Charge
- Excellent CdV/dt effect decline
- 100% EAS Guaranteed
- Green Device Available

### Absolute Maximum Ratings

Symbol	Parameter	Rating	Units
$V_{DS}$	Drain-Source Voltage	650	V
$V_{GS}$	Gate-Source Voltage	$\pm 30$	V
$I_D@T_C=25^\circ C$	Continuous Drain Current, $V_{GS} @ 10V^1$	4	A
$I_D@T_C=100^\circ C$	Continuous Drain Current, $V_{GS} @ 10V^1$	2.6	A
$I_{DM}$	Pulsed Drain Current <sup>2</sup>	8	A
EAS	Single Pulse Avalanche Energy <sup>3</sup>	26.2	mJ
$I_{AS}$	Avalanche Current	7	A
$P_D@T_C=25^\circ C$	Total Power Dissipation <sup>4</sup>	41.6	W
$T_{STG}$	Storage Temperature Range	-55 to 150	$^\circ C$
$T_J$	Operating Junction Temperature Range	-55 to 150	$^\circ C$

### Thermal Data

Symbol	Parameter	Typ.	Max.	Unit
$R_{\theta JA}$	Thermal Resistance Junction-ambient (Steady State) <sup>1</sup>	---	62	$^\circ C/W$
$R_{\theta JC}$	Thermal Resistance Junction-Case <sup>1</sup>	---	3	$^\circ C/W$

### Product Summary



BVDSS	RDSON	ID
650V	2.6 $\Omega$	4A

### Applications

- High efficient switched mode power supplies
- Electronic lamp ballast
- LCD TV/ Monitor
- Adapter

### TO220FL Pin Configuration

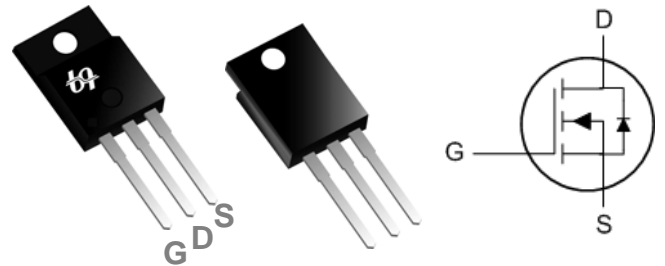

### Electrical Characteristics ( $T_J=25^\circ\text{C}$ , unless otherwise noted)

Symbol	Parameter	Conditions	Min.	Typ.	Max.	Unit
$BV_{DSS}$	Drain-Source Breakdown Voltage	$V_{GS}=0V, I_D=250\mu A$	650	---	---	V
$\Delta BV_{DSS}/\Delta T_J$	$BV_{DSS}$ Temperature Coefficient	Reference to $25^\circ\text{C}$ , $I_D=1\text{mA}$	---	0.69	---	V/ $^\circ\text{C}$
$R_{DS(ON)}$	Static Drain-Source On-Resistance <sup>2</sup>	$V_{GS}=10V, I_D=2A$	---	2.1	2.6	$\Omega$
$V_{GS(th)}$	Gate Threshold Voltage	$V_{GS}=V_{DS}, I_D=250\mu A$	2	---	5	V
$\Delta V_{GS(th)}$	$V_{GS(th)}$ Temperature Coefficient		---	-8.2	---	mV/ $^\circ\text{C}$
$I_{DSS}$	Drain-Source Leakage Current	$V_{DS}=520V, V_{GS}=0V, T_J=25^\circ\text{C}$	---	---	2	$\mu A$
$I_{GSS}$	Gate-Source Leakage Current	$V_{GS}=\pm 30V, V_{DS}=0V$	---	---	$\pm 100$	nA
gfs	Forward Transconductance	$V_{DS}=15V, I_D=2A$	---	3	---	S
$R_g$	Gate Resistance	$V_{DS}=0V, V_{GS}=0V, f=1\text{MHz}$	---	3.4	6.8	$\Omega$
$Q_g$	Total Gate Charge (10V)	$V_{DS}=520V, V_{GS}=10V, I_D=1A$	---	18	---	nC
$Q_{gs}$	Gate-Source Charge		---	4.9	---	
$Q_{gd}$	Gate-Drain Charge		---	6.1	---	
$T_{d(on)}$	Turn-On Delay Time	$V_{DD}=300V, V_{GS}=10V, R_G=10\Omega, I_D=1A$	---	11.2	---	ns
$T_r$	Rise Time		---	18.8	---	
$T_{d(off)}$	Turn-Off Delay Time		---	29.2	---	
$T_f$	Fall Time		---	29.2	---	
$C_{iss}$	Input Capacitance	$V_{DS}=25V, V_{GS}=0V, F=1\text{MHz}$	---	775	---	pF
$C_{oss}$	Output Capacitance		---	56	---	
$C_{rss}$	Reverse Transfer Capacitance		---	3.8	---	

### Guaranteed Avalanche Characteristics

Symbol	Parameter	Conditions	Min.	Typ.	Max.	Unit
EAS	Single Pulse Avalanche Energy <sup>5</sup>	$V_{DD}=50V, L=1\text{mH}, I_{AS}=4A$	8.6	---	---	mJ

### Diode Characteristics

Symbol	Parameter	Conditions	Min.	Typ.	Max.	Unit
$I_S$	Continuous Source Current <sup>1,6</sup>	$V_G=V_D=0V$ , Force Current	---	---	4	A
$I_{SM}$	Pulsed Source Current <sup>2,6</sup>		---	---	8	A
$V_{SD}$	Diode Forward Voltage <sup>2</sup>	$V_{GS}=0V, I_S=1A, T_J=25^\circ\text{C}$	---	---	1	V
$t_{rr}$	Reverse Recovery Time	$I_F=1A, di/dt=100A/\mu s, T_J=25^\circ\text{C}$	---	195	---	nS
$Q_{rr}$	Reverse Recovery Charge		---	580	---	nC

Note :

1. The data tested by surface mounted on a 1 inch<sup>2</sup> FR-4 board with 20Z copper.
2. The data tested by pulsed, pulse width  $\leq 300\mu s$ , duty cycle  $\leq 2\%$
3. The EAS data shows Max. rating. The test condition is  $V_{DD}=50V, V_{GS}=10V, L=1\text{mH}, I_{AS}=7A$
4. The power dissipation is limited by  $150^\circ\text{C}$  junction temperature
5. The Min. value is 100% EAS tested guarantee.
6. The data is theoretically the same as  $I_D$  and  $I_{DM}$ , in real applications, should be limited by total power dissipation.

### Typical Characteristics

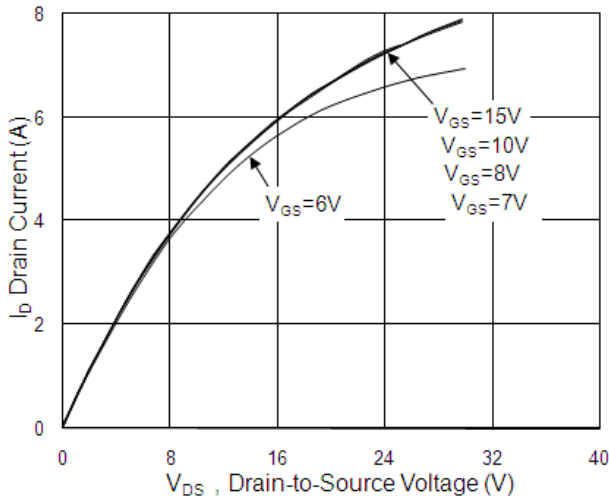

Fig.1 Typical Output Characteristics

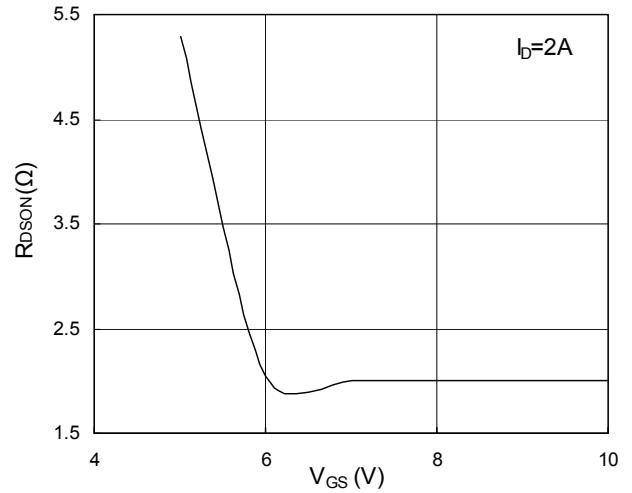

Fig.2 On-Resistance vs. G-S Voltage

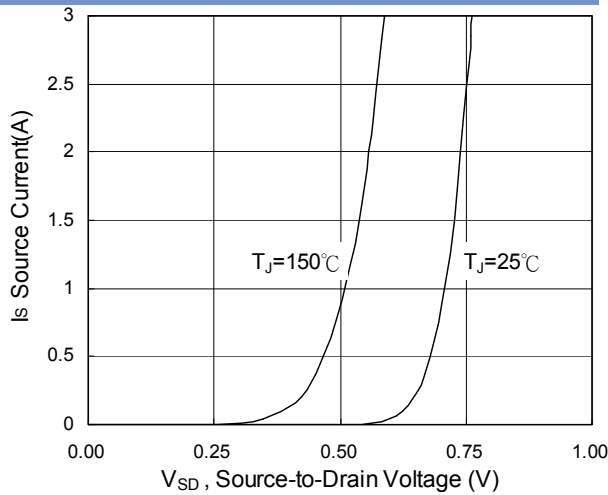

Fig.3 Forward Characteristics of Reverse

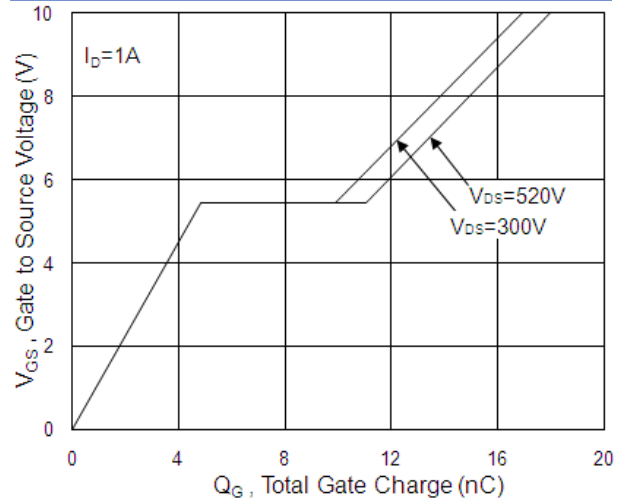

Fig.4 Gate-Charge Characteristics

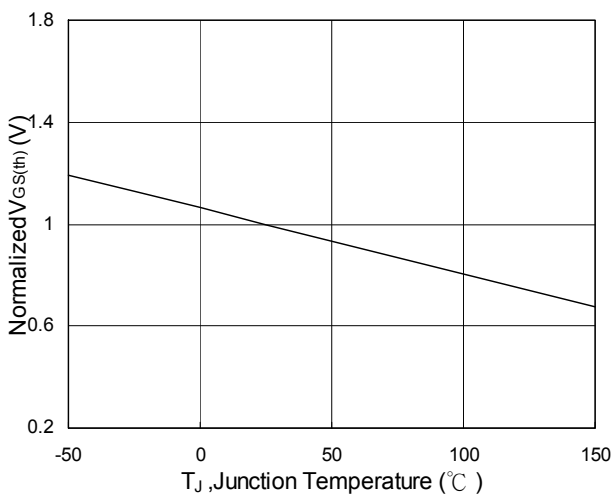

Fig.5 Normalized  $V_{GS(th)}$  vs.  $T_J$

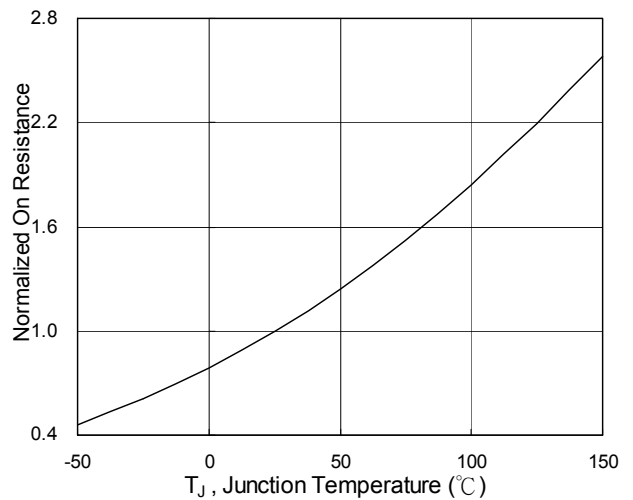

Fig.6 Normalized  $R_{DS(on)}$  vs.  $T_J$

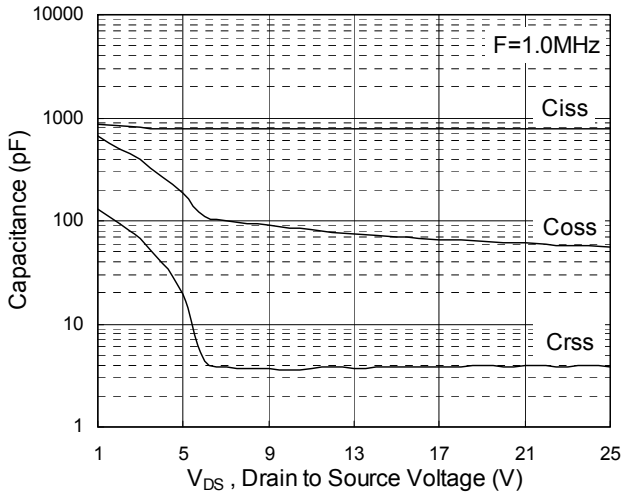

Fig.7 Capacitance

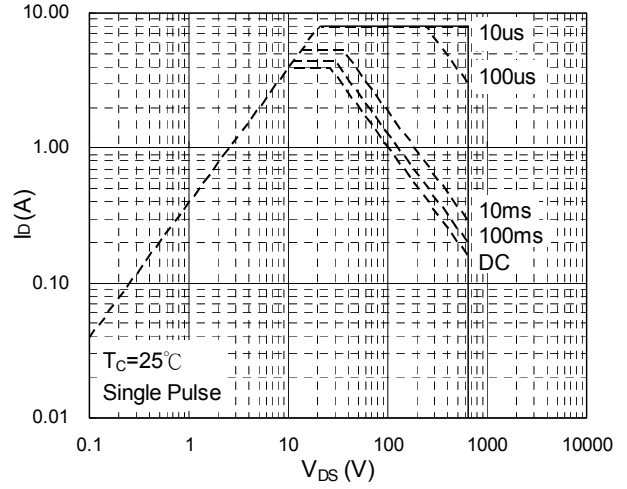

Fig.8 Safe Operating Area

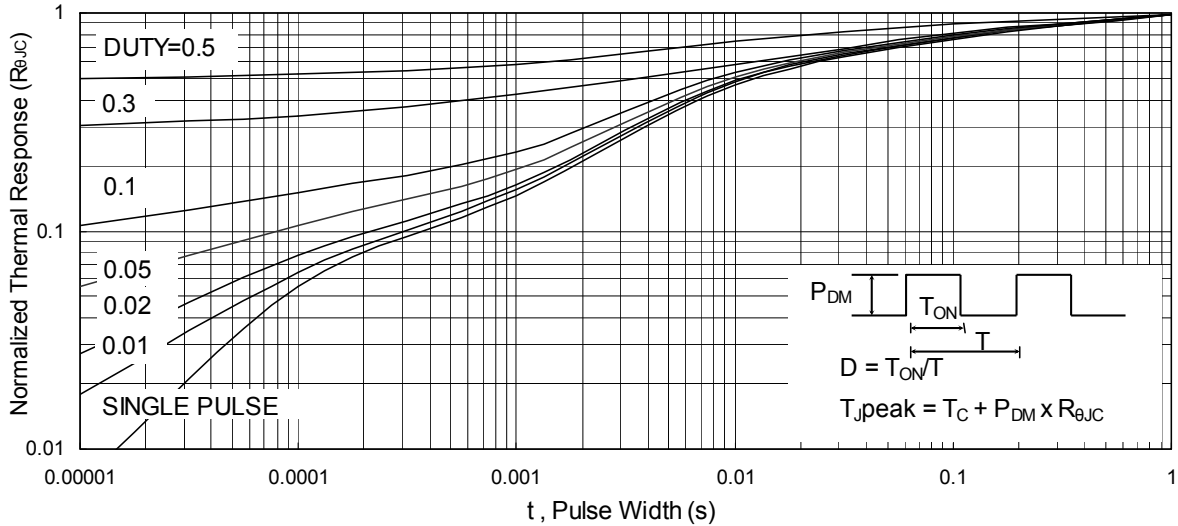

Fig.9 Normalized Maximum Transient Thermal Impedance

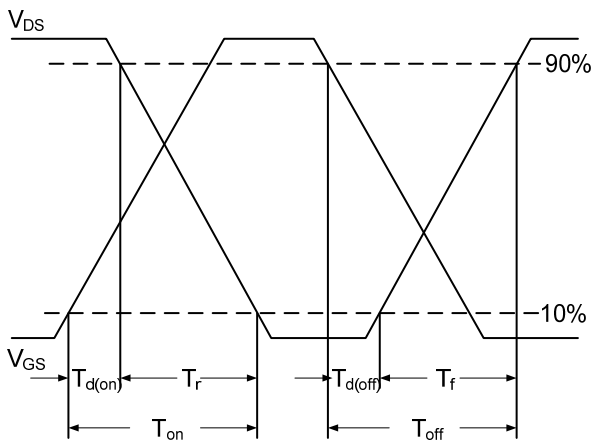

Fig.10 Switching Time Waveform

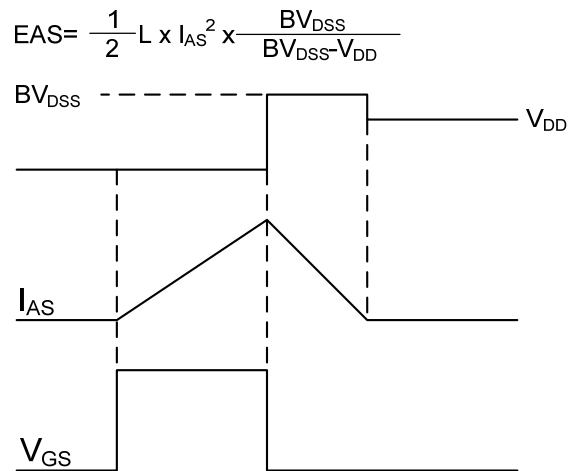

Fig.11 Unclamped Inductive Switching Waveform